

QUICKSILVER®
ACTIV

SUNDECK – CRUISER



THE QUICKSILVER ACTIV RANGE HAS ALWAYS PERFECTLY BLENDED FUN AND STYLE WITH PRACTICALITY AND SAFETY.

The evolving direction of the Quicksilver Activ range now builds on this strength with collaborations between highly experienced designers, engineers and naval architects from the Brunswick Group, a leading force in the boating world. A strong partnership that has led to an even greater line-up of fun boats with true integrity and depth.

Quicksilver Activ promises a world of style and innovative use of space made possible by the best in class length to beam ratio which also increases stability. A confidence further heightened by the deep V hull design creating a form that cuts through water efficiently and comfortably. A direct result of one of the most experienced naval architects in the industry being part of the team behind Quicksilver Activ.

So as you can see, we take fun very seriously. Welcome to style and substance.

Explore our complete range of boats and dealer network now at

www.quicksilver-boats.com

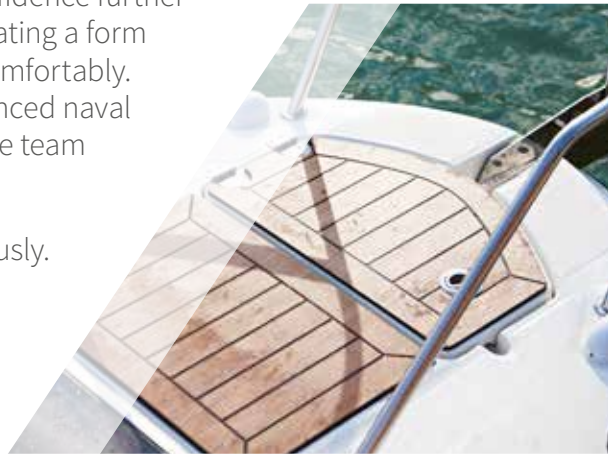



Life is now

CONTENT

Introduction	4
The Smart Edition	5
ACTIV 875 SUNDECK	6
ACTIV 805 SUNDECK	10
ACTIV 755 SUNDECK	14
ACTIV 675 SUNDECK	18
ACTIV 605 SUNDECK	22
ACTIV 805 CRUISER	26
ACTIV 755 CRUISER	30
ACTIV 675 CRUISER	34
NEW ACTIV 605 CRUISER	38
ACTIV 555 CABIN	42
ACTIV 505 CABIN	46
ACTIV 455 CABIN	50
Specifications	54

WELCOME TO THE CRUISER & SUNDECK RANGE FROM QUICKSILVER.

The moment you look at an Activ, you know that it's designed for pure fun.

It's about fluid yet solid forms with soft lines and sharp, cut-through shapes creating a dynamic, sporty tension that says it's playtime. Purposeful designs still true to the essence and character of the original sketches; that spontaneous spark of inspiration. Creativity founded on experience, considered development and insight gained through solid research into the needs and desires of boat users resulting in a range of boats that offers you true freedom with the reassurance of structural and engineering integrity. Everything underpinned by safety, comfort and versatility. So you can cruise, water ski, or just soak up the sun with complete peace of mind. And with ease.

This is Activ.
Built on understanding.
Shaped by you.
Created for escape.

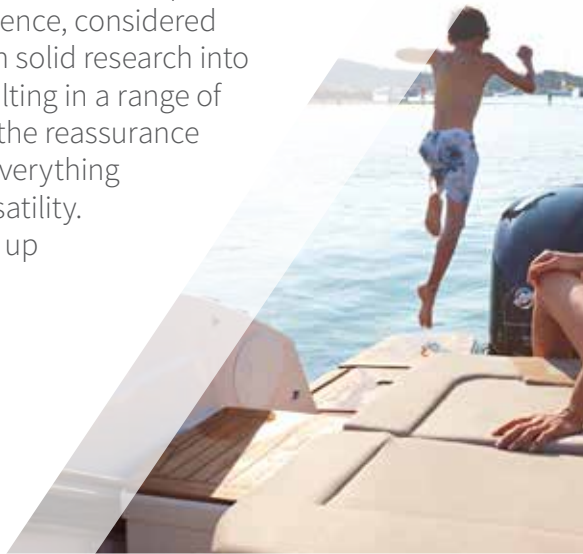



SMART EDITION THE BEST WAY TO GET THE OPTIONS YOU NEED

People are different. So why should every boat be the same? We have designed our boats for optimal use, but we know that everybody has their own preferences. That's why we are introducing the Smart Edition.

The Smart Edition gives you what you need: a variety of option sets that are most frequently requested by our customers. So you can be sure you get the options you want.

Best of all, the Smart Edition has short delivery times and is probably already available at your local dealer right now – you'll be on the water before you know it.

ACTIV 875 SUNDECK

SUNDECK CHAMPION

The Activ 875 Sundeck is raising the bar. Or should we say: extending the sun lounge? It boasts the biggest sundeck in its category. So, go ahead and invite up to 12 people for a cruise in the sun or onboard BBQ. Friends can even join for multi-day trips, because the cabin sleeps 4.



Length Overall (m)	8,06
Beam Maximum (m)	3
Height - Without Canvas (m)	2,71
Dry Weight (Kg)	2462
Fuel Capacity (L)	450
CE Design Category	B/C
Maximum Number of People	10/12
Maximum Power (HP/KW)	500 / 368

ACTIV 875 SUNDECK



SAFETY

The boat is powered by a single engine with up to 400 hp or a twin engine with up to 500 hp. There is no better guarantee for safe travels in all kinds of water and wind conditions. On board, the asymmetrical console leaves ample space to easily reach the foredeck by the starboard side. And of course, the Activ 875 Sundeck's offer a stable and spacious deck to move around on.

COMFORT

With the Activ 875 Sundeck, there's enough sundeck for everybody. The cockpit seating converts into a 1.9 x 1.6 m sun lounge with direct water access while the bow area measures a record-setting 2.25 x 2.25 m sundeck with adjustable backrest. That's as big as it gets in this category of boats. Meanwhile, the cabin holds anything else you might need, like a marine toilet and shower. The cosy cabin seating and dining area with beautiful view over the water is conveniently equipped with an optional fridge and microwave.

DESIGN

The Activ 875 Sundeck's design is a triumph of aesthetics and space efficiency. Take the helm, with its stylish glass windshield and classy dual seat. When you slide the seat forward on its rails, a galley with integral sink, cutting board and an optional stove or grill reveals itself. The cabin makes the most out of the available space with a U-shaped lounge that converts into the main berth. Design lovers will appreciate the privilege pack filled with exclusive design features.

VERSATILITY

An L-shaped cockpit lounge that converts into a large sundeck or a dining area, with a galley at hand. Not bad, right? Wait, there's more. Water sport fans put the engine's horsepower to good use by adding a ski pole to their configuration. Another option? Just flip up the foredeck chaise sun lounge and relax. The cabin area is ideal for eating in, relaxing and sleeping.

SMART EDITION

Be sure to get what you need: the Smart Edition is based on the options that are most frequently requested by our customers. In addition to that you save an average of 10 % when compared to ordering options separately and this edition is probably already available at your local dealer right now.



ACTIV 875 SUNDECK



1 & 2

Versatile cockpit area convertible to completely extended sun lounge area for maximum sunbathing capacity and easy water access. Flip seats



7 & 8

Adjustable sun lounge backrest. Extra-large sundeck for sunbathing, socializing or just relaxing.

Enclosed canvas



Bimini



3

Fully equipped galley

Dual helm seat with bolsters and armrest on starboard side. Ergonomic helm with a dash designed for a 12" GPS or twin 9" GPS screens and instrumentation



4 & 5



1 & 12

Versatile cockpit area convertible to extra-large sun lounge and easy water access. Swim platform extensions.



18 Mid-cabin berth with storage and side windows

Enclosed sea toilet with sink and pressured water, shower and toilet with electric flushing system



19

MODEL FEATURES

1. Versatile cockpit area, convertible for: 1) cruising and dining area 2) sun lounge area with inclinable backrest 3) extra-large sun lounge and easy water access
2. Flip seats
3. Fully equipped galley with sink with pressured water, cutting board, dual burner LPG or Electric grill, and a side fridge drawer. The helm seat is mounted on rails and slides forward to reveal the galley.
4. Dual helm seat with bolsters and armrest on starboard side
5. Ergonomic helm with a dash designed for a 12" GPS or twin 9" GPS screens and instrumentation
6. Port & starboard steps to access foredeck
7. Adjustable sun lounge backrest
8. Extra-large sundeck for sunbathing, socializing or just relaxing
9. Fully recessed anchor locker and integrated windlass with remote control
10. Wide cockpit entry with transom door
11. Large cockpit floor storage
12. Swim platform extensions
13. Motor well step: easy access to both sides of transom
14. Multiple engine configuration: single up to 400 hp or twin up to max 500 hp
15. U-lounge seating convertible to a dining area and main berth of 2 by 1.80m
16. Large hull side windows with opening portlights and a foredeck hatch
17. Interior galley with a 50L refrigerator and a microwave
18. Mid-cabin berth with storage and side windows
19. Enclosed sea toilet with sink and pressured water, shower and toilet with electric flushing system
20. Wide steps to access the cabin

Interior galley with a 50L refrigerator and a microwave



17



15 & 16



U-lounge seating convertible to a dining area and main berth of 2 by 1.80m. Large hull side windows with opening portlights and a foredeck hatch.

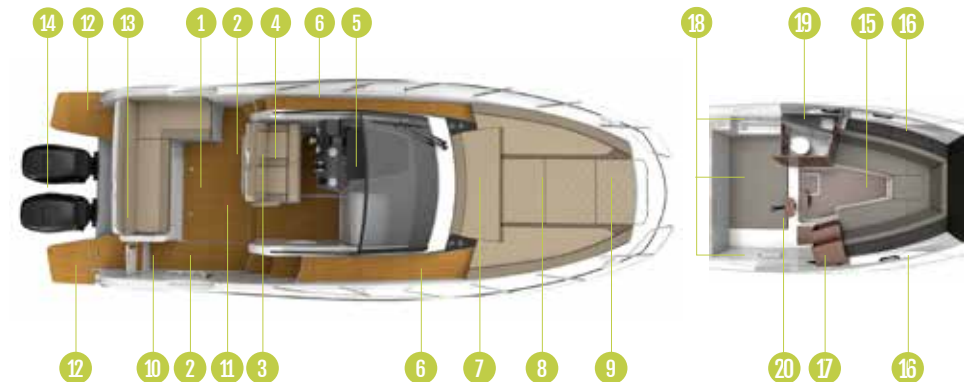

ACTIV 805 SUNDECK

SUN, SEA AND UNMISTAKABLE STYLE

If you're looking for the perfect combination of performance and comfort in the 7-8 meter range, then look no further than Quicksilver's Activ 805 Sundeck. Designed with sun and relaxed cruising and water sports in mind, the Activ 805 Sundeck lives up to its name with a versatile configuration that offers one of the largest sundeck surface in its category. But it's also big on comfort, accommodating up to nine people and comfortable sleeping for up to four adults. Not to mention performance and safety values for which Quicksilver craft are renowned.



Length Overall (m)	7,88
Beam Maximum (m)	2,55
Height - Without Canvas (m)	2,71
Dry Weight (Kg)	1820
Fuel Capacity (L)	280
CE Design Category	C
Maximum Number of People	9
Maximum Power (HP/KW)	400 / 294

ACTIV 805 SUNDECK



SAFETY

The Activ 805 Sundeck offers a wide range of safety features that will allow you to enjoy the water in complete security. Powerful single or twin-engine option delivers great acceleration and top speed, while Mercury technology ensures safe and precise handling. Its solid hull, high freeboards and ergonomic helm make it an extremely safe boat at any speed and in a variety of weather conditions.

COMFORT

With overnight accommodation facilities designed to cater for up to four adults in complete comfort, the Activ 805 Sundeck offers a spacious cabin with a private bathroom with sink and optional marine toilet. For daytime use the Activ 805 Sundeck accommodates up to nine adults in comfort and style, making it perfect for unforgettable high-performance leisure cruising, sun bathing and fun with friends and family.

DESIGN

With its sleek, fluid lines, the Activ 805 Sundeck's stylish proportions create an unmistakable presence on the water. Both above decks and below, the Activ 805 Sundeck offers stylish design elements such as clever extra seating around the cabin L-shape table, and a translucent cabin door and large hullside windows, providing lots of light in the cabin and a spacious and airy feeling.

VERSATILITY

The last word in versatility, the Activ 805 Sundeck offers the largest Sundeck area in its class, with an easily deployable forward sunbathing area featuring twin chaise-lounges and a wide flat area, as well as versatile cockpit area. The cockpit can be transformed from a seating area to a dining area and a large sundeck in just minutes. The cabin is perfect to accommodate up to four people for overnighting but the main berth can also be converted into a seating area with table.

SMART EDITION

Be sure to get what you need: the Smart Edition is based on the options that are most frequently requested by our customers. In addition to that you save an average of 10 % when compared to ordering options separately and this edition is probably already available at your local dealer right now.



ACTIV 805 SUNDECK



1

Versatile cockpit area convertible to completely extended sun lounge area for maximum sunbathing capacity and easy water access*



1 & 4

Versatile cockpit area convertible to dining area
Permanent galley with stainless steel sink, cutting board, standard 12V cooler/fridge, LPG stove*



1

Versatile cockpit area convertible to sun lounge area with inclined backrest



13, 14 & 15

Wide aft cockpit entry.
Double swim platforms.
Motor well bridge: easy access to both sides of transom.



9

Easy and wide steps to bow sun lounge area

Ergonomic helm with instrumentation, 9" Simrad GPS/Chart Plotter and SmartCraft instrumentation



6

10



Large and versatile forward sun lounge with 3 adjustable backrests for sitting, sun bathing and chaise lounge position

12



Separated head with sink and toilet

Cabin: for 4 adults. The main berth is convertible to a seating area with table. Door and large windows in the hull provide ample natural light in the cabin area

Translucent cabin



8



12

MODEL FEATURES

1. Versatile cockpit area, convertible for: 1) cruising and dining area 2) sun lounge area with inclined backrest, ideal for reading and relaxing 3) completely extended sun lounge area for maximum sunbathing capacity and easy water access
2. Flip seat
3. Convenient storage below cockpit floor
4. Permanent galley with stainless steel sink with cutting board lid, standard 12V cooler, fridge & countertop stove
5. Easy walking access from bow to stern
6. Ergonomic helm with instrumentation, 9" Simrad Chart Plotter and SmartCraft instrumentation
7. Comfortable bucket seats or leaning post. New seat design as of MY2019 not shown in brochure.
8. Translucent cabin door and large windows in the hull provide ample natural light in the cabin area
9. Easy and wide steps to bow sun lounge area
10. Large and versatile forward sun lounge with 3 adjustable backrests for sitting, sun bathing and chaise lounge position
11. Anchor storage/windlass
12. Cabin for 4 adults consisting of main forward berth, mid berth, separated head and sink and toilet. The main berth is convertible to a seating area with table.
13. Wide aft cockpit entry
14. Double swim platforms
15. Motor well bridge: easy access to both sides of transom
16. Single or twin engine configuration capability of max 400 hp

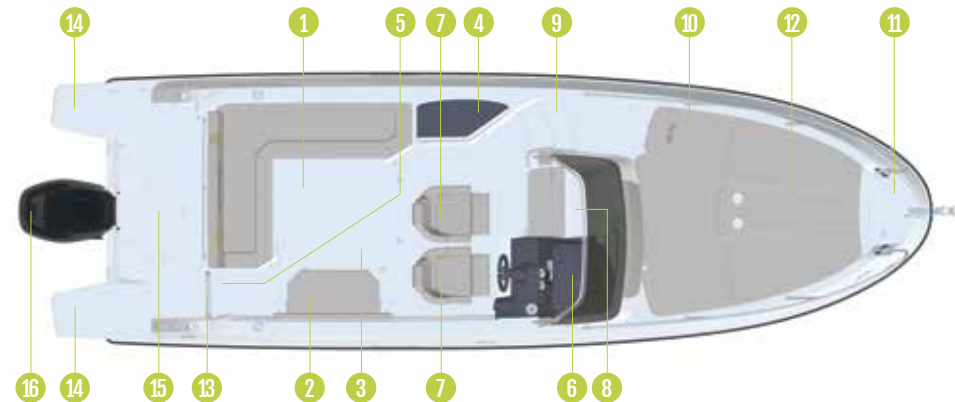

ACTIV 755 SUNDECK

LIVE ON THE SUNNY SIDE OF LIFE

The perfect combination of performance, comfort and versatility in the 7m+ boat segment, Quicksilver's Activ 755 Sundeck is designed with sun, relaxation and enjoyable cruising in mind. With a range of versatile configurations that offer great sun lounging as well as seating accommodation facilities, the Activ 755 Sundeck is designed for fast day cruising and water sports for up to eight people and comfortable overnighting for two.



Length Overall (m)	7,23
Beam Maximum (m)	2,55
Height - Without Canvas (m)	2,21
Dry Weight (Kg)	1468
Fuel Capacity (L)	280
CE Design Category	C
Maximum Number of People	8
Maximum Power (HP/KW)	300 / 221

ACTIV 755 SUNDECK



SAFETY

Unmistakably a high-performance craft, the Activ 755 Sundeck also offers a full range of safety features to allow you, your friends and family to enjoy the water in complete security. On the move, the up to 300 horsepower outboard power unit gives the Activ 755 Sundeck plenty of power, while its excellent handling and ergonomic pilot post make it a joy to use for water sports and fast cruising.

COMFORT

With its extra-large sunbathing foredeck area, with integrated headrests and cup holders, the Activ 755 Sundeck offers optimal sunbathing conditions for up to 3 people. Enjoy a cold drink or a meal thanks to the galley that comes with sink, running water, refrigerator and a single burner stove for maximum comfort. Inside, the cabin offers comfortable daytime and dining use for up to four people, as well as overnighting for two.

DESIGN

Fluid, sleek and stylish are the watchwords when it comes to the new Activ 755 Sundeck's exterior design, while the intelligent design features onboard, make this stylish craft an experience not to be missed. From the helm station's excellent console layout, to the multiple seating configurations both in the cabin and the cockpit, the Activ 755 Sundeck uses intelligent design to offer a maximum of possibilities.

VERSATILITY

The last word in versatility, the Activ 755 Sundeck offers a large forward sunbathing area, a versatile cockpit seating that can transform to a dining area and a cabin configuration that can also be used for dining, sleeping for two, and even as a comfortable play area for children.

SMART EDITION

Be sure to get what you need: the Smart Edition is based on the options that are most frequently requested by our customers. In addition to that you save an average of 10% when compared to ordering options separately and this edition is probably already available at your local dealer right now.



ACTIV 755 SUNDECK

14



Large permanent bow sundeck area*

6



Versatile cockpit area with standard L-lounge seat configuration that can partially be cleared for easy access to transom and extendable to U-lounge with port flip-up seat.

13



Side steps provide easy access to bow sundeck area

12



The cabin seating area is convertible to a dining area or 2 berths

7



Dining table in cockpit*

Double swim platforms. Motor well bridge: easy access to both sides of transom



2 & 3



9

Port galley includes stainless steel sink with cutting board lid, fridge & LPG stove



10

Ergonomic helm with instrumentation and 7" Simrad GPS/Chart Plotter

Twin bucket seats adjustable in height and flip up bolsters. New seat design as of MY2019 not shown in brochure.

Integrated swim ladder



1



8

MODEL FEATURES

1. Integrated swim ladder
2. Double swim platforms
3. Motor well bridge: easy access to both sides of transom
4. Transom door
5. Storage under cockpit seating
6. Versatile cockpit area with standard L-lounge seat configuration that can partially be cleared for easy access to transom and extendable to U-lounge with port flip-up seat.
7. Dining table
8. Twin bucket seats adjustable in height and flip up bolsters. New seat design as of MY2019 not shown in brochure.
9. Galley includes stainless steel sink with cutting board lid, fridge & LPG stove
10. Ergonomic helm with instrumentation and 7" Simrad GPS/Chart Plotter
11. Lockable acrylic sliding cabin entry door
12. Cabin with concealed sea toilet. The cabin seating area is convertible to a dining area or 2 berths
13. Side steps provide easy access to bow sundeck area
14. Large permanent bow sundeck area
15. Anchor storage/windlass

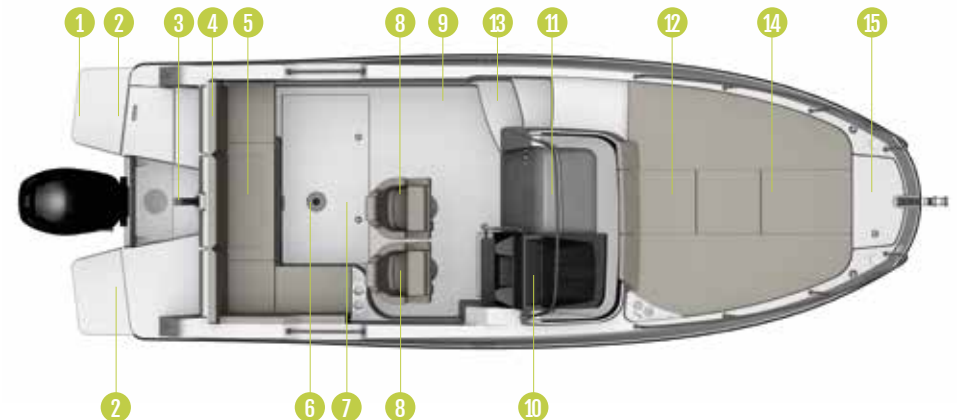

ACTIV 675 SUNDECK

SUN LOVER

The Activ 675 Sundeck's updated, contemporary design wows in any water. And there's much more than meets the eye. Jump aboard to experience for yourself how space, comfort and ergonomics come together. For example, the helm now makes better use of the available surface, is easier to work with and has improved functionalities. Along with you behind the wheel, there's room for up to 8 passengers who want to soak up the sun.



Length Overall (m)	6,66
Beam Maximum (m)	2,55
Height - Without Canvas (m)	2,10
Dry Weight (Kg)	1123
Fuel Capacity (L)	200
CE Design Category	C
Maximum Number of People	8
Maximum Power (HP / KW)	225 / 165



SAFETY

The Activ 675 Sundeck is powered by an outboard Mercury engine with up to 225 hp. On board, accessibility to the bow and to other parts of the boat is high thanks to the wide steps to the bow, intelligently placed handrails and a high freeboard. A restyled windshield with new tinted glass (30/70 blend) was developed to improve the pilot's view. Water enthusiasts will love the pivoting backrest to reach the swim platforms effortlessly.

COMFORT

The 2-meter long sundeck is raising the bar for all sundecks in this boat's category. If you can't stand the heat, stay out of the sun lounge. Which is very well possible. A sliding door leads into the cabin with plenty of seating space. At night, it's converted into a comfortable double berth. In the cockpit, the improved pilot bucket seats swivel any way you like and have been reinforced to offer more comfort.

VERSATILITY

The cockpit is the most versatile area on the Activ 675 Sundeck. A pivoting backrest leads to the swim platform and the ski mast. After a bit of water sports action, a removable table and the pivoting pilot seats turn the cockpit into a fancy dining area for 4. Starboard and portside integrated cup holders included. The cabin configuration is multi-purposeful as well. Enjoy some relaxing time on the U-shaped seating or transform the cabin into a cosy bedroom for 2.

STORAGE

Storage space easy to find on the Activ 675 Sundeck. A non-exhaustive list includes the space underneath the aft seating, ample room in the cabin and a storage tray in the helm console. This means there's dedicated storage for both your permanent equipment (cushions, exterior table, ski mast, navigation light, life jackets) and for other small items and personal belongings.

SMART EDITION

Be sure to get what you need: the Smart Edition is based on the options that are most frequently requested by our customers. In addition to that you save an average of 10% when compared to ordering options separately and this edition is probably already available at your local dealer right now.



ACTIV 675 SUNDECK



12 Large bow sun lounge



9 Cockpit table



6

8 & 11 Twin cup holders. Stylish and ergonomic bicolor helm with room for 7" GPS/Chart Plotter



8 & 11

Port and starboard pivoting backrest allowing an easy access to the swim platforms



16

U shape seating in cabin



17

Double berth designed for comfortably sleeping two adults



3

Large swim platforms for safe and easy access in and out of the water

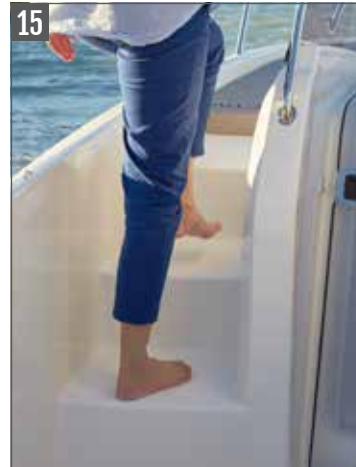

15

Wide steps to forward sun lounge



1 & 4

Engine configuration up to max 225 hp.
Cockpit shower



Semi-transparent sliding door

14

MODEL FEATURES

1. Engine configuration up to max 225 hp
2. Integrated swim ladder
3. Large swim platforms for safe and easy access in and out of the water
4. Cockpit shower
5. Ski pole
6. Port and starboard pivoting backrest allowing an easy access to the swim platforms
7. Storage below aft seat
8. Twin cup holders
9. Cockpit table
10. Pivoting pilot & co-pilot bucket seats with flip bolster and swivel. New seat design as of MY2019 not shown in brochure.
11. Stylish and ergonomic bicolor helm with room for 7" GPS/Chart Plotter
12. Large bow sun lounge
13. Integrated electric bow windlass
14. Semi-transparent sliding door
15. Wide steps to forward sun lounge
16. U shape seating in cabin
17. Double berth designed for comfortably sleeping two adults

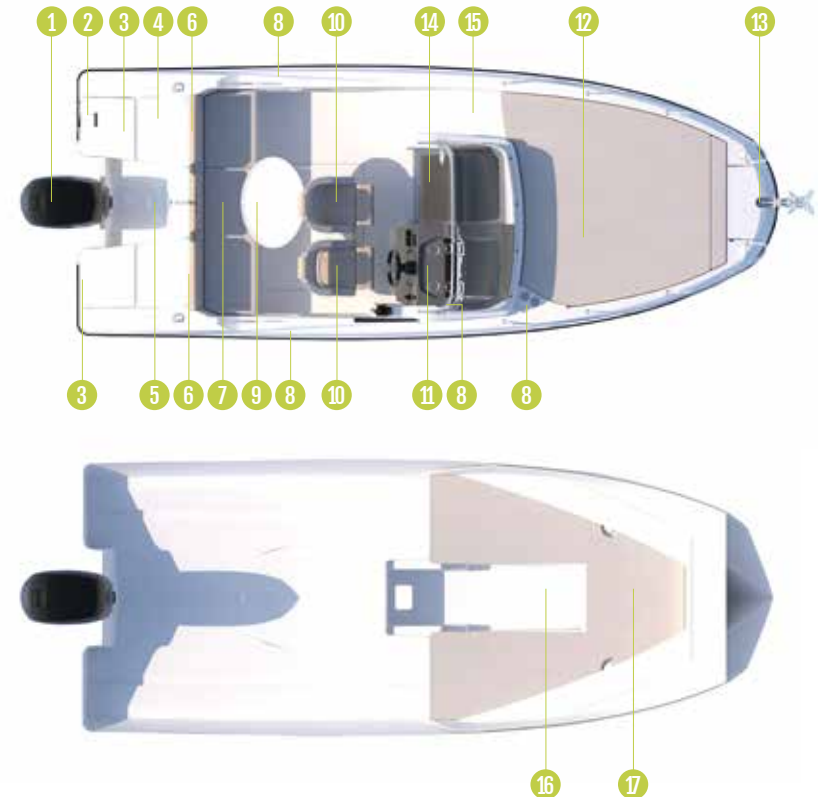

ACTIV 605 SUNDECK

FUN IN THE SUN

The improved Activ 605 Sundeck hits the water with a more dynamic design and upgraded functionalities. It is made for cruising, water sports and fun in the sun. So head out for a day trip with up to 7 people or surprise your partner with a romantic getaway. A Mercury engine with up to 150 hp guarantees safe navigation during the day and the boat's cabin converts into a cosy berth at night.



Length Overall (m)	5,94
Beam Maximum (m)	2,40
Height - Without Canvas (m)	2,02
Dry Weight (Kg)	970
Fuel Capacity (L)	160
CE Design Category	C
Maximum Number of People	7
Maximum Power (HP / KW)	150 / 110



SAFETY

Safety begins with a reliable engine. The Activ 605 Sundeck is compatible with a series of single outboard Mercury engines (115-150 hp). On board, wide steps to the sun lounge area, a high freeboard and well-placed handrails provide passengers with all the support and comfort they need to move around freely. A pivoting backrest allows for an unobstructed access to the swim platforms and the integrated swim ladder.

COMFORT

The Activ 605 Sundeck has one of the largest sundecks in its category. Even the bow anchor locker is covered with a cushion to extend the sunbathing area to the max. The helm of the boat has been completely redesigned for a more modern, stylish look and improved use of space for instrumentation. At the same time, the pilot and co-pilot bucket seats with flip bolsters, swivels have been fortified for enhanced driver comfort.

VERSATILITY

Flexibility is a given on the new Activ 605 Sundeck, both on and below the deck. The cockpit converts into a dining area for up to 4 adults, thanks to the removable table, starboard and portside integrated cup holders and pivoting pilot seats. Cabin space can be used as a U-shaped seating area or as a comfortable 2-person sleeping berth, depending on the cushion configuration. An optional ski mast adds water sports to the list of activities the boat has in store.

STORAGE

Storage capacity on the boat is plentiful. For starters, the bow anchor and line locker are fully integrated. The exterior table and filler cushions fit into a dedicated storage area and the same goes for the stern navigation light and water sports equipment. Supplementary storage space for small items and personal belongings is located both underneath the aft seat and below the berth in the cabin.

SMART EDITION

Be sure to get what you need: the Smart Edition is based on the options that are most frequently requested by our customers. In addition to that you save an average of 10 % when compared to ordering options separately and this edition is probably already available at your local dealer right now.



ACTIV 605 SUNDECK

15



Wide steps to forward sun lounge

14



Semi-transparent sliding door

Engine configuration up to max 150 hp.
Easy and unobstructed access to and from the swim platforms via a pivoting backrest



1 & 6

Double berth



17

Ski pole



5

8 & 11



Twin cup holders.
Stylish and ergonomic bicolor helm with room for 7" GPS/Chart Plotter



3

Large swim platforms for safe and easy access in and out of the water



16

U shape seating in cabin

Pivoting pilot & co-pilot bucket seats with flip bolster and swivel. New seat design as of MY2019 not shown in brochure.



10



12

Large bow sun lounge

MODEL FEATURES

1. Engine configuration up to max 150 hp
2. Integrated swim ladder
3. Large swim platforms for safe and easy access in and out of the water
4. Cockpit shower
5. Ski pole
6. Easy and unobstructed access to and from the swim platforms via a pivoting backrest
7. Storage below aft seat
8. Twin cup holders
9. Cockpit table
10. Pivoting pilot & co-pilot bucket seats with flip bolster and swivel. New seat design as of MY2019 not shown in brochure.
11. Stylish and ergonomic bicolor helm with room for 7" GPS/Chart Plotter
12. Large bow sun lounge
13. Integrated electric bow windlass
14. Semi-transparent sliding door
15. Wide steps to forward sun lounge
16. U shape seating in cabin
17. Double berth

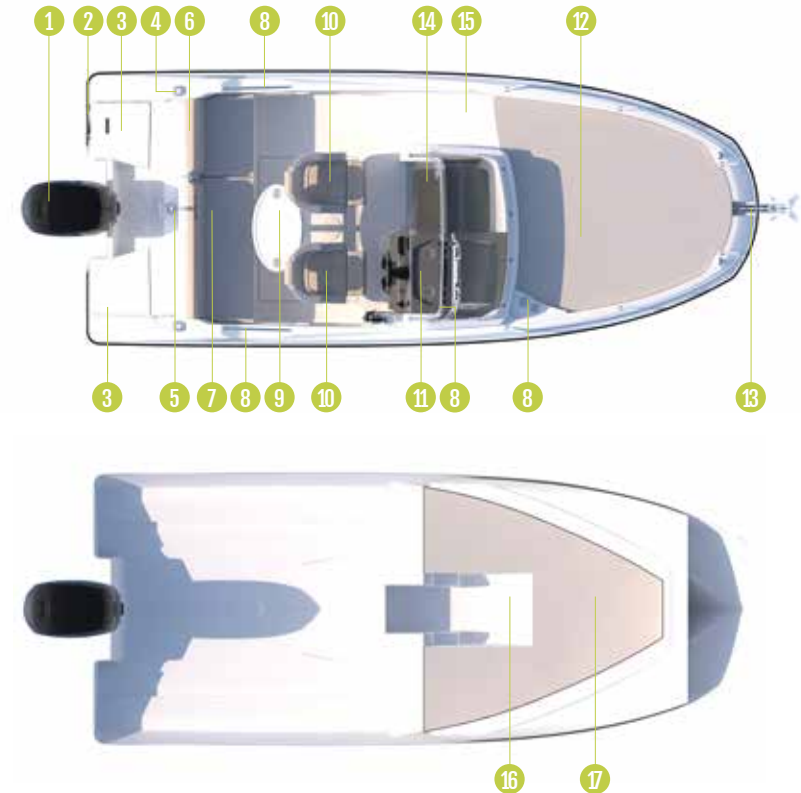

ACTIV 805 CRUISER

LUXURY PERFORMANCE DAY-CRUISER

Designed with attention to detail, the Activ 805 Cruiser is our flagship model for day cruising. Refinement, power, safety and comfort are the key values you'll appreciate in this smart new addition to our line-up. Powered by up to 400hp of engine power and accommodating up to nine for day cruising and refined sport and leisure use with family and friends, the Activ 805 Cruiser is the ultimate in smooth and stylish performance on the water.



Length Overall (m)	7,88
Beam Maximum (m)	2,55
Height - Without Canvas (m)	2,26
Dry Weight (Kg)	1813
Fuel Capacity (L)	280
CE Design Category	C
Maximum Number of People	9
Maximum Power (HP/kW)	400 / 294

ACTIV 805 CRUISER



SAFETY

The Activ 805 offers a wide range of safety features that will allow you to enjoy the water in complete security. With a hull designed for safe yet high-performance use and a high level of navigation console accessibility and visibility, it's an extremely safe craft at any speed and in a variety of weather conditions. The easy stern access and twin swim platforms include a robust ladder allowing for equally easy access directly from the water.

DESIGN

With its sleek, fluid lines, the Activ 805 Cruiser's perfect proportions create a powerful presence on the water. The high-spec exterior fittings and intelligent design elements give the boat a unique style, complemented by high-end finishing such as LED courtesy lights and teak cockpit table. The interiors are fitted out in elegance and style, with eye for detail in the upholstery finishing, cabinets and wooden trim giving an overall sense of refinement.

COMFORT

With overnight accommodation facilities designed to cater for up to four adults, the Activ 805 Cruiser offers a spacious and airy double forward cabin, twin mid-berths, a practical yet private marine toilet with its own window and sink and a robust and practical galley with a refrigerator, fresh water system and stove. For daytime use the Activ 805 Cruiser accommodates up to nine adults in comfort and style.

VERSATILITY

The last word in versatility, the Activ 805 Cruiser offers multiple configurations for fun and leisure use with family and friends, whether it's for skiing, water sports or coastal cruising. Three different cockpit configurations from comfortable cockpit seating to dining area and to spacious sun lounge. The cockpit dining table seats five people. Not to mention an optional full size foredeck sun lounge.

SMART EDITION

Be sure to get what you need: the Smart Edition is based on the options that are most frequently requested by our customers. In addition to that you save an average of 10% when compared to ordering options separately and this edition is probably already available at your local dealer right now.



ACTIV 805 CRUISER



1 Versatile cockpit area, convertible to completely extended sun lounge area for maximum sunbathing capacity and easy water access*



1 Versatile cockpit area, convertible to sun lounge area with inclined backrest, ideal for reading and relaxing*



1 Versatile cockpit area, convertible to dining area



2 Permanent galley with stainless steel sink with cutting board lid, standard 12V cooler, fridge & LPG stove



12

Enclosed canvas storage

Comfortable bucket seat. Double co-pilot seat with storage below seat. New seat design as of MY2019 not shown in brochure.



16 & 17

7-8&10



Main forward berth with large skylights and deck hatch

10



Separated head with sink & sea toilet

10



Mid berth with 2 single or one double berth

5



Easy walking access from bow to stern

MODEL FEATURES

1. Versatile cockpit area, convertible for:
 - 1) cruising and dining area
 - 2) sun lounge area with inclined backrest, ideal for reading and relaxing
 - 3) completely extended sun lounge area for maximum sunbathing capacity and easy water access
2. Permanent galley with stainless steel sink with cutting board lid, standard 12V cooler, fridge & LPG stove
3. Ergonomic helm with instrumentation, 9" Simrad GPS/Chart Plotter and SmartCraft instrumentation
4. Storage area for small items and beverages in front of pilot and co pilot seats
5. Easy walking access from bow to stern
6. Wide steps to access the foredeck
7. Large skylights on deck and the side of the hull for ample light in cabin
8. Cabin hatch provides ventilation
9. Anchor storage/windlass
10. Cabin for 4 adults consisting of main forward berth, mid berth, separated sink and toilet
11. Wide aft cockpit entry
12. Enclosed canvas storage
13. Double swim platforms
14. Motor well bridge: easy access to both sides of transom
15. Single or twin engine configuration capability of max 400 hp
16. Comfortable bucket seat. New seat design as of MY2019 not shown in brochure.
17. Double co-pilot seat with storage below seat

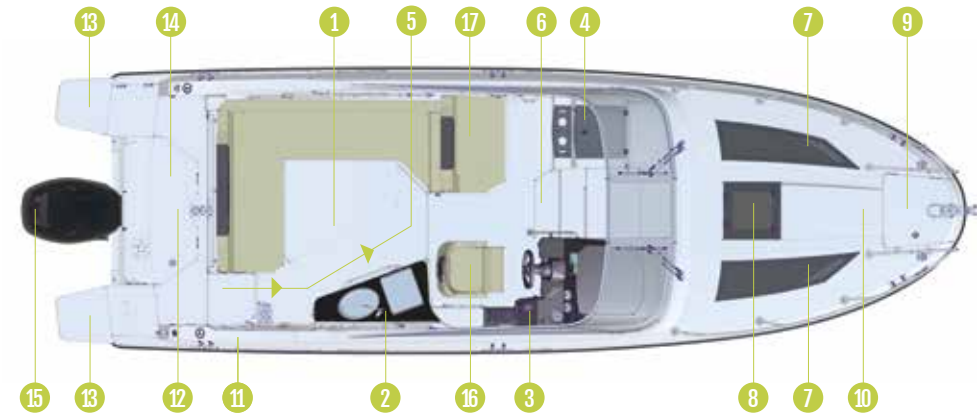

ACTIV 755 CRUISER

ENJOY THE VIEW

Break away for a day trip or a weekend on the water. The Activ 755 Cruiser's deep cockpit and full windscreen keep you and your passengers safe and dry during the ride. Inside, the cabin's wide windows offer the best views you'll ever find in a 7-meter boat. Customisation is key. The cockpit area offers 3 configurations, several packs allow for significant upgrades of the boat's accessories and there's a whole range of Mercury engines available.



Length Overall (m)	6,99
Beam Maximum (m)	2,56
Height - Without Canvas (m)	2,03
Dry Weight (Kg)	1440
Fuel Capacity (L)	280
CE Design Category	C
Maximum Number of People	8
Maximum Power (HP/KW)	300 / 221



SAFETY

The Activ 755 Cruiser is powered by a single outboard Mercury engine with up to 300 hp, ensuring secure and agile navigation. Accessibility features include a wide cockpit entry, smartly positioned handrails all around, easy walking access from bow to stern and swim platforms to slide into the water. With its deep cockpit, the boat is also suitable to take children along for a safe ride. A full windscreen with windscreen wiper adds to the weather protection.

DESIGN

Its distinctive external lines give the boat an uncluttered, smooth and sporty look. Eye catchers are the bicolour helm, the sleek windshield and the new electric blue hull colour. Smart design created room for integrated armrests with cup holders, a cockpit galley for outside cooking and invisible canvas storage. The cabin makes the most of the available space and light with a roomy berth, large windows and integrated storages.

COMFORT

Passengers are well taken care of wherever they are on the Activ 755 Cruiser. The large cockpit lets you enjoy being outside and on the water as much as possible. It includes a fully galley with sink, LPG stove and refrigerator. Large swim platforms provide easy access to the water and wide steps do the same for cabin entry. The cabin boasts room for 2 to spend the night and see the sun rise through its wide side windows. Plus, there's an optional full enclosed marine toilet.

VERSATILITY

How do you like your cockpit area? Its adjustable reclining bench offers 3 configurations: up, chaise lounge and extra-large sun lounge. These let you choose from a multitude of activities: talk, dine, relax, read, sunbathe, you name it! The co-pilot seat has a dual function as well. Sit down in the forward-facing seat or use it to extend the seating area and sun lounge. Want even more space? The foredeck transforms into a sun lounge, too.

SMART EDITION

Be sure to get what you need: the Smart Edition is based on the options that are most frequently requested by our customers. In addition to that you save an average of 10 % when compared to ordering options separately and this edition is probably already available at your local dealer right now.



ACTIV 755 CRUISER



1 & 6

Versatile cockpit area: Suitable for 1. Cruising and dining
2. Relaxing and reading with the inclinable backrest 3. Extra-large sun lounge for a maximum sunbathing capacity and easy water access.
Storage below seating and dedicated storage for the cockpit table*



Galley with integral sink, cutting board and LPG stove



Ergonomic helm with SmartCraft instrumentation with mounting space for 9" GPS/Chart Plotter



Swim platform extensions

Double co-pilot seat with bi-directional seat backrest and storage underneath the seat



2



Integrated armrests and blue LED cup holders on both starboard and portside

5

15, 19 & 20



Large skylight on deck for ample light in cabin. Spacious cabin with double berth and large storage below. Large side windows with opening portlights for natural lighting and ventilation

21



Enclosed sea toilet

MODEL FEATURES

1. Versatile cockpit area: Suitable for 1. Cruising and dining 2. Relaxing and reading with the inclinable backrest 3. Extra-large sun lounge for a maximum sunbathing capacity and easy water access
2. Double co-pilot seat with bi-directional seat backrest and storage underneath
3. Galley with integral sink, cutting board and LPG stove
4. Ergonomic helm with SmartCraft instrumentation with mounting space for 9" GPS/Chart Plotter
5. Integrated armrests and blue LED cup holders on both starboard and portside
6. Storage below seating and dedicated storage for the cockpit table
7. Convenient storage area for small items in front of the co-pilot seat
8. Deep cockpit for more safety and dryer ride
9. Wide aft cockpit entry
10. Integrated canvas storage
11. Swim platform extensions
12. Single engine configuration up to max 300 hp
13. Comfortable bucket seat with flip bolster & swivel
14. Permanent and easy access to the cabin and foredeck
15. Large skylight on deck for ample light in cabin
16. Anchor storage/windlass
17. Large foredeck sun lounge for reading and relaxing
18. Safe access via the bow
19. Spacious cabin with double berth and large storage below
20. Large side windows with opening portlights for natural lighting and ventilation
21. Enclosed sea toilet
22. Wide step for convenient and safe access
23. Bench with storage underneath

Permanent and easy access to the cabin and foredeck



14

17



Large foredeck sun lounge for reading and relaxing*

*New upholstery colors as of MY2020, not shown in brochure

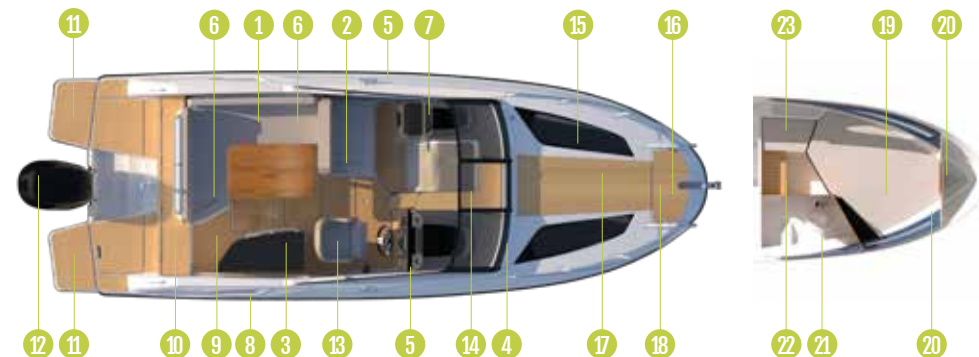

ACTIV 675 CRUISER

SLEEK, SPORTY AND SPACIOUS

The Activ 675 Cruiser combines a sleek design with a sporty set-up and smart use of space. That makes it hard to tell who will have the most fun: you as the captain or the friends and family you bring along? There's room for up to 7 people who love to cruise and soak up the sun.



Length Overall (m)	6,48
Beam Maximum (m)	2,46
Height - Without Canvas (m)	1,83
Dry Weight (Kg)	1234
Fuel Capacity (L)	230
CE Design Category	C
Maximum Number of People	7
Maximum Power (HP / KW)	225 / 165



SAFETY

A clearly defined step-out area tells all passengers where to enter and exit the boat. This allows you to get in the boat in a fast and secure manner. Once on board, there's easy walking access from bow to stern. And if you want to go for a swim, the large swim platform is the way to go. An ergonomic helm station and a deep cockpit make sure captain, crew and kids are safe at all times.

COMFORT

Large portside steps give easy access to the foredeck. This unique deck layout frees up space in the centre of the boat. And that is where you'll find a semi-transparent door. Slide it open to enter the U-shaped cabin that converts into a comfortable double berth. Ample light and ventilation are provided through the translucent cabin door, an opening portlight and a deck hatch. Back outside, the helm can be equipped with SmartCraft instrumentation and, a high tech 9-inch GPS.

VERSATILITY

Most of the action on the Activ 675 Cruiser happens in the cockpit area. The double, bi-directional co-pilot seat makes it possible remain face forward when cruising or extend the social area to spend time together. Over dinner, for example. And if you add the starboard flip seat to your boat configuration, even more people gather around the cockpit table. The cockpit can be turned into a sun lounge within minutes. And, if you put the aft seat down that sun lounge becomes even bigger.

STORAGE

Storage space is integrated below the swim platform and underneath the cockpit seats. All of that space is available to store away personal belongings. The fenders, and even the optional canvas all have their own dedicated storage space. Of course, you'll find even more storage room in the cabin.

SMART EDITION

Be sure to get what you need: the Smart Edition is based on the options that are the most frequently requested by our customers. In addition to that you save an average of 10% when compared to ordering options separately and this edition is probably already available at your local dealer right now.



ACTIV 675 CRUISER



7

Versatile cockpit area suitable for sun lounge and extended sun lounge with easy water access



Bimini



4

Stylish windshield and ergonomic helm station. With instrumentation and mounting space for a 9" GPS/Chart plotter.



1

Deck with hatch that can be converted to sun lounge

Versatile cockpit area suitable for cruising and dining. Double co-pilot seat with bi-directional seat backrest and optional refrigerator below seat.



7,9



7

Versatile cockpit area suitable for relaxing and reading with the inclinable backrest

18



Cabin with seating area that is convertible to a double berth

19



Optional pull out marine toilet

3



Wide steps to access foredeck



Mooring cover

MODEL FEATURES

1. Foredeck with hatch that can be converted to sun lounge
2. Anchor storage and step-out area via the bow
3. Wide steps to access deck
4. Stylish windshield and ergonomic helm station. With instrumentation and mounting space for a 9" GPS/Chart plotter.
5. Integrated armrests and cup holder
6. Semi-transparent sliding cabin door
7. Versatile cockpit area suitable for 1. Cruising and dining, 2. Relaxing and reading with the inclinable backrest, 3. Sun lounge and extended sun lounge with easy water access
8. Pilot bolster seat
9. Double co-pilot seat with bi-directional seat backrest and optional refrigerator below seat
10. Dedicated fenders storage
11. Cockpit hatch for easy access to underdeck components
12. Deep cockpit to ensure children's and adult's safety when moving around the boat
13. Integrated canvas storage
14. Plenty of convenient storage throughout the boat
15. Large swim platforms and motor well step for easy access to both sides of transom
16. Swim ladder
17. Single engine configuration up to max 225 hp
18. Cabin with seating area that is convertible to a double berth
19. Optional pull out marine toilet
20. Opening portlight

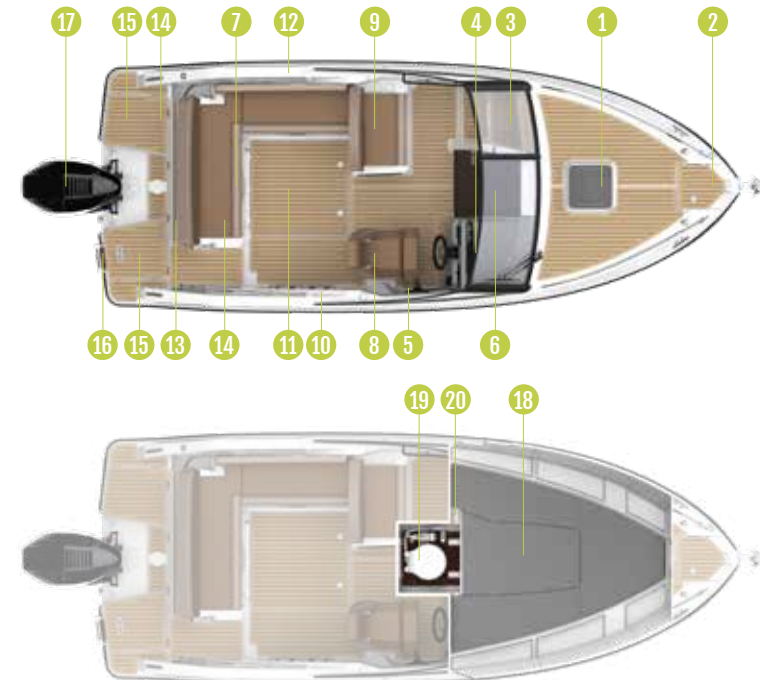

ACTIV 605 CRUISER

CHOOSE TO CRUISE

The Activ 605 Cruiser has gotten longer and wider compared to its predecessor, but it's still our most compact cruiser. The redesign gives you a bigger, more streamlined boat. Also interesting to know: your increased cruising comfort is coupled with longer cruising, thanks to the biggest fuel tank in this category.



Length Overall (m)	6,02
Beam Maximum (m)	2,34
Height - Without Canvas (m)	1,75
Dry Weight (Kg)	1074
Fuel Capacity (L)	160
CE Design Category	C
Maximum Number of People	6
Maximum Power (HP / KW)	150 / 110



SAFETY

As you know, a bigger boat is often a safer boat. You enter and leave the Activ 605 Cruiser via a clearly defined step-in/step-out area. The large swim platform with motor well step ensures easy access into the water and back onto the deck. Also, if you bring your kids and they can't sit still (no surprises there), that's completely fine. The high foredeck railing and the deep cockpit allow them to move around in all safety during family cruises.

COMFORT

As the boat's captain, you'll be happy to see that your swivel seat is now mounted on a polyester pedestal base, for improved comfort. Your co-pilot, in a similar seat, looks straight at cleverly placed steps to the foredeck. This unique design allows for a cabin door in the middle of the cockpit. The semi-transparent door, an opening portlight and a deck hatch let light and air into the cabin. Inside, a double berth fits 2 people who love spending the night afloat.

VERSATILITY

Up to 6 people find at least as many ways to spend time on the Activ 605 Cruiser. The foredeck is convertible into a large sun lounge with a central backrest cushion. At the back, blue skies ask for the optional second sun lounge to be deployed. In case of grey clouds, however, a bimini is deployed just as fast. The other option? Find shelter in the cabin, it doubles as a U-shaped seating area and as a berth for 2.

STORAGE

Your personal belongings stay dry in storage spaces underneath the swim platform and below the aft seating. A third storage space is integrated under the seating area of the cabin. Of course, the fenders and optional features such as an enclosure or a dining table all have their own spaces just as well.

SMART EDITION

Be sure to get what you need: the Smart Edition is based on the options that are most frequently requested by our customers. In addition to that you save an average of 10% when compared to ordering options separately and this edition is probably already available at your local dealer right now.



ACTIV 605 CRUISER

18



Cabin with seating area that is convertible to a double berth

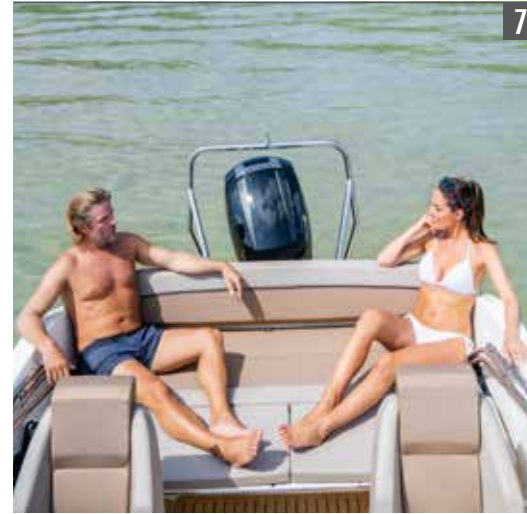

7

Versatile cockpit area for sunbathing with easy deployable sun lounge



Optional bimini



Optional ski arch for water sports

19



Optional refrigerator

Versatile cockpit area suitable for cruising, dining



7



4

Stylish windshield and ergonomic helm station. With instrumentation and mounting space for a GPS/Chart plotter



3 & 6

Wide steps to access deck
Semi-transparent sliding cabin door

MODEL FEATURES

1. Deck with hatch that can be converted to sun lounge
2. Anchor storage and step-out area via the bow
3. Wide steps to access deck
4. Stylish windshield and ergonomic helm station. With instrumentation and mounting space for a GPS/Chart plotter.
5. Integrated armrests and cup holder
6. Semi-transparent sliding cabin door
7. Versatile cockpit area suitable for cruising, dining and sunbathing with easy deployable sun lounge
8. Pilot bolster seat
9. Co-pilot seat with bi-directional seat backrest
10. Dedicated fenders storage
11. Cockpit hatch for easy access to under-deck components
12. Deep cockpit to ensure children's and adult's safety when moving around the boat
13. Integrated canvas storage
14. Plenty of convenient storage throughout the boat
15. Large swim platforms and motor well step for easy access to both sides of transom
16. Swim ladder
17. Single engine configuration up to max 150 hp
18. Cabin with seating area that is convertible to a double berth
19. Optional refrigerator
20. Opening portlight



15

Large swim platforms and motor well step
Optional cockpit shower



2

Anchor storage and step-out area via the bow

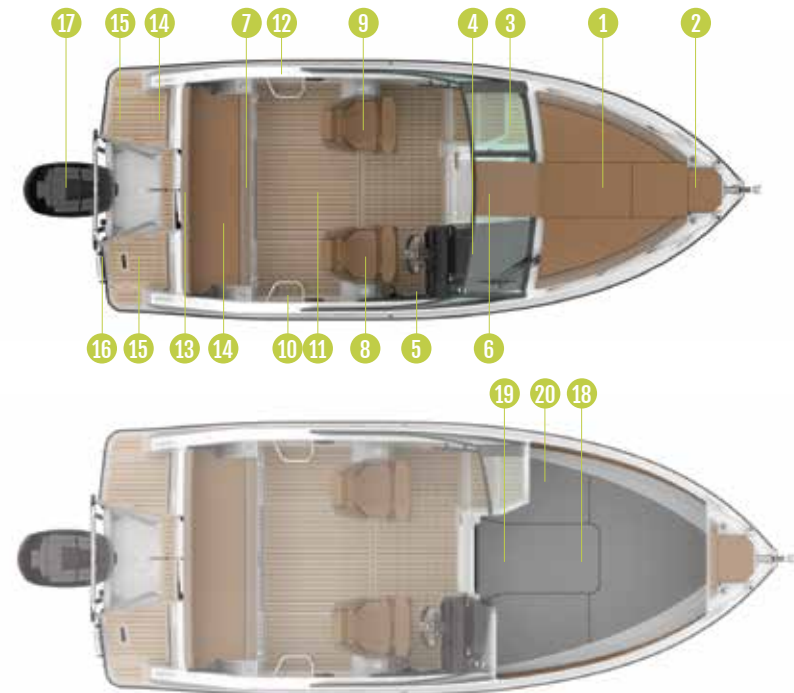

ACTIV 555 CABIN

ANYTHING GOES

The Activ 555 Cabin comes prepared. What for? Basically anything. First and foremost, it contains everything you need for a good time. Choose a spot on the bow or cockpit sun lounge, grab a drink from the fridge or enjoy your favourite tunes on the stereo system that can be equipped with 4 speakers.



Length Overall (m)	5,50
Beam Maximum (m)	2,29
Height - Without Canvas (m)	1,71
Dry Weight (Kg)	865
Fuel Capacity (L)	110
Design Category	C
Maximum Number of People	6
Maximum Power (HP/kW)	115/84,6



SAFETY

Navigation becomes a breeze with the standard hydraulic steering system, an integrated footrest and room for a 7 inch GPS screen. On the deck, you and your passengers walk around in all safety. You'll find wide port steps for easy foredeck access, an anti-skid deck trail and helpful hand rails. Do you feel in for a swim? Use the integrated swim platform or get the extended one to slide in gently.

COMFORT

The helm of the Activ 555 Cabin was designed to improve functionality and optimise space. As a pilot, everything you need is at your fingertips. There's a sport steering wheel, integrated armrest and footrests, and with the Activ Trim, you can count on effortless and optimal engine performance. Whenever you feel like taking a break, you just turn off the engine and swivel your chair around to face your crew. Indoors, cabin space has been optimised and the interior headliner gives a touch of cosiness. A translucent sliding door and side foredeck skylights add to a luminous and comfortable stay.

VERSATILITY

The Activ 555 Cabin is a year-round all-rounder. It has nice places to relax all around. Pivoting seats and a mountable table turn the cockpit into a dining area right away. But first, you might want to deploy the cockpit sun lounge. Or go to the bow sun deck, of course. As soon as night falls or clouds gather, the cabin awaits you. Either sit down around the cosy cabin table or convert the seating into a spacious double berth of 2 meters.

STORAGE

In the cockpit area, storage space is conveniently tucked away below the aft bench seating. Supplementary storage is integrated in the helm and in the cabin. Combined, the Activ 555 Cabin is equipped with plenty of space to keep personal belongings, sun pads and other items dry and safe.

SMART EDITION

Be sure to get what you need: the Smart Edition is based on the options that are most frequently requested by our customers. In addition to that you save an average of 10 % when compared to ordering options separately and this edition is probably already available at your local dealer right now.



ACTIV 555 CABIN



3

Cockpit sun lounge extension: flip-up system without leg support or extensions

Helm with room for a 7" GPS/Chart plotter and instrumentation. Ergonomic armrest and cup holder



8 & 9



10

Port steps for an easy access to the bow area



13

Bow sun lounge

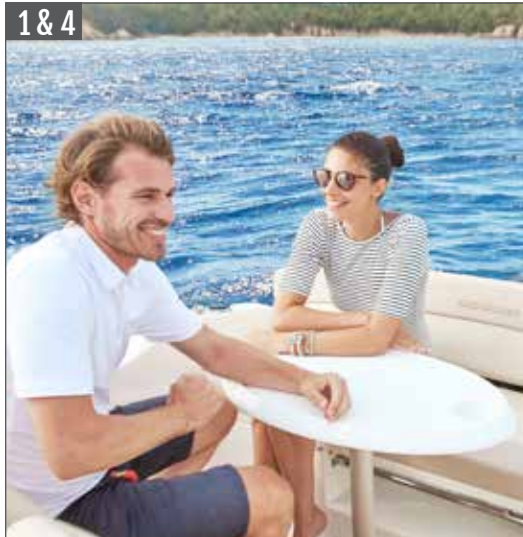

1 & 4

Bench seat for 3 people. Cockpit table



Bimini & enclosed canvas

14 & 15



Foredeck opening hatch.
Cabin with U shape seating and cabin table convertible into a 2 meters double berth

2



Reclining center backrest to allow full tilt engine position and maximal cockpit space

15



Cabin with U shape seating and cabin table.
Refrigerator.

Swim platform extensions.
Swim ladder



17 & 19

MODEL FEATURES

1. Bench seat for 3 people
2. Reclining center backrest to allow full tilt engine position and maximal cockpit space
3. Cockpit sun lounge extension: flip-up system without leg support or extensions
4. Cockpit table
5. Cockpit hatch for easy access to under deck components
6. Pivoting pilot and co-pilot bucket seats
7. High freeboard for more safety
8. Helm with room for a 7" GPS/Chart plotter and instrumentation
9. Ergonomic armrest and cup holder
10. Port steps for an easy access to the bow area
11. Cabin access through sliding door
12. Anti-skid port deck trail for easy bow access
13. Bow sun lounge
14. Foredeck opening hatch
15. Cabin with U shape seating and cabin table convertible into a 2 meters double berth
16. Large recessed anchor/line storage
17. Swim platform extensions
18. Engine configuration up to max 115 hp
19. Swim ladder

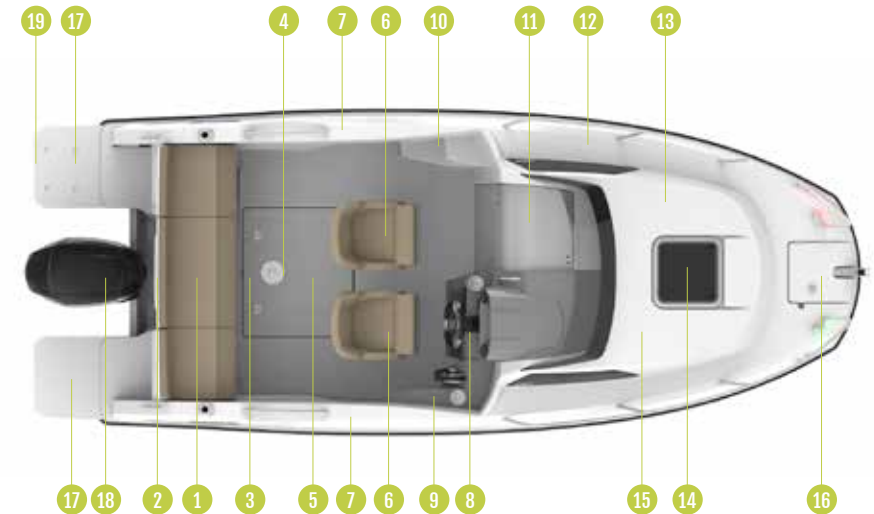

ACTIV 505 CABIN

THE BEST ALL-ROUND CABIN CRUISER IN THE COMPACT CLASS

The Activ 505 Cabin offers one of the best all-round boating and navigation experiences in its class, integrating a stylish new design and packed with improved new features that guarantee a new level of safety and pleasure for a day on the water.



Length Overall (m)	5,41
Beam Maximum (m)	2,12
Height - Without Canvas (m)	1,64
Dry Weight (Kg)	613
Fuel Capacity (L)	50
Design Category	C
Maximum Number of People	5
Maximum Power (HP/kW)	100/73,6



SAFETY

Step aboard and leave with peace of mind, knowing that your safety is guaranteed by the robust hull and intelligent design features that make the Activ 505 Cabin a reassuring choice on the water. Improved transom access, anti-slip bow and foredeck with guardrail protection mean total security in moving around the boat. The outboard power of up to 100 horsepower combined with responsive, reliable handling make the Activ 505 Cabin a dream on the water, offering all-round safety, comfort and fun for friends and family.

DESIGN

Fans of better boat design will love the new look – and feel – of the Activ 505 Cabin. From its stylish lines to the intelligent design features throughout, the Activ 505 Cabin packs a design punch that sends it to first in its class. The Activ 505 Cabin's profile is stylish and sporty, while the interior cabin experience is enhanced by plenty of natural light and space for portable toilet.

COMFORT

With overnight accommodation facilities designed to cater up to two adults in, the Activ 505 Cabin offers a cabin that maximises space and comfort with longer berths and space for a toilet that stows away when not in use. The ample lighting comes from two well-placed port and starboard portlights and from the semi-transparent sliding cabin. The well-protected cockpit offers seating for up to 5 people and converts to a picnic area. The optional bimini awning and cockpit sun lounge top the comfort list, providing sunlounging as well as shade and protection.

VERSATILITY

Whether you're looking a day boat for family and friends or an overnighter that sleeps two, the Activ 505 Cabin offers all the versatility you need to get the most out of your boating. The cockpit, with its bench seating, combines practicality and comfort. The movable middle-seat serves as transom entry. The cockpit table makes just the spot for a picnic, while an optional second pilot bucket seat extends the full cockpit seating capacity up to five. Inside the cabin, an optional central filler creates an extra-wide berth, while storage is integrated throughout the boat; in both cockpit and the cabin.



ACTIV 505 CABIN



6 Cockpit sun lounge extension



4 Bench seat for 3 people



7 Storage under cockpit seating



14 Safe access to the bow

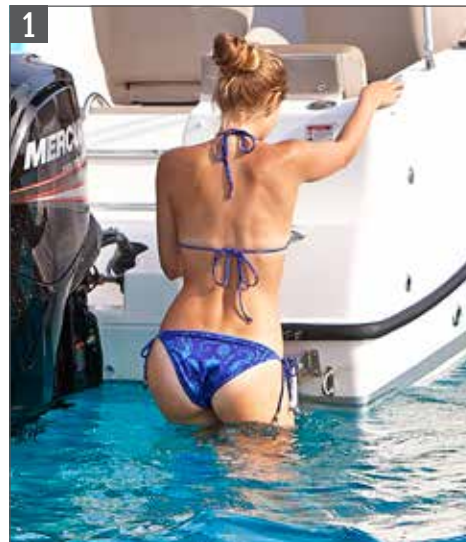

1 Swim ladder



Bench seating flips up to allow boat access via the stern. Integrated step for boarding access

2 & 3



5

Cockpit table for dining



13

Cabin with double berth



13

Cabin with double berth



12

Lockable acrylic sliding cabin entry door

MODEL FEATURES

1. Swim ladder
2. Bench seating flips up to allow boat access via the stern
3. Integrated step for boarding access
4. Bench seat for 3 people
5. Cockpit table for dining
6. Cockpit sun lounge extension
7. Storage under cockpit seating
8. High freeboard for children' safety
9. Pilot bucket seat
10. Co-pilot bucket seat
11. Ergonomic helm with mounting area for 7" GPS/Chart plotter
12. Lockable acrylic sliding cabin entry door
13. Cabin with double berth
14. Safe access to the bow
15. Anchor locker

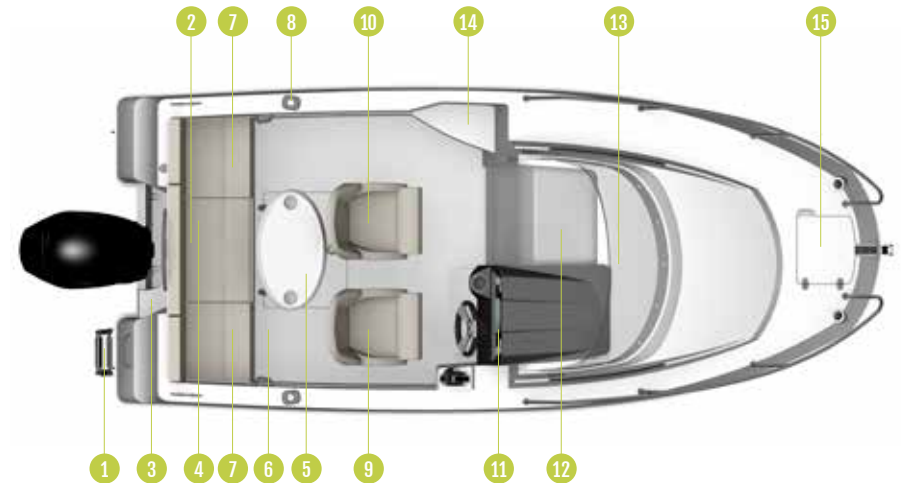

ACTIV 455 CABIN

QUALITY, COMFORT AND FUN IN ONE COMPACT PACKAGE

With its sleek, up-to-the-minute styling, improved safety and more space than ever, the Activ 455 Cabin offers water and boating enthusiasts the perfect boat to explore the world of sea and inshore waters. Not to forget the unbeatable package price, which make this the perfect boat if you are looking for comfort at an affordable price.



Length Overall (M)	4,44
Beam Maximum (M)	2,12
Height - Without Canvas (M)	1,63
Dry Weight (Kg)	538
Fuel Capacity (L)	25
Design Category	C
Maximum Number of People	4
Maximum Power (HP/kW)	60/44,1



SAFETY

Just step aboard and you'll immediately be reassured by the easy and safe transom access, the bow section and foredeck with its guardrail protection and the excellent anti-slip deck surfaces that guarantee safety for both children and adults. With its robust hull, the Activ 455 Cabin boasts a deep, well-protected cockpit with double bucket seats (co-pilot seat is optional) for improved safety and comfort, and a redesigned helm and dash that offers space for a GPS screen of up to 7".

DESIGN

Despite its compact size, the Activ 455 Cabin's new, stylish lines, and redesigned interior proportions give it an allure that puts it in a class ahead. In fact, almost the entire craft design has been re-thought, from the helm position and console, to the new, high-protection windscreen design, to the neat, easy-access transom boarding and the roomy, well-lit interior cabin with space for a toilet.

COMFORT

With overnight accommodation facilities designed to cater for up to two adults, the Activ 455 Cabin offers a larger cabin that maximises space and comfort with longer berths and space for a toilet that can be stowed away when not in use. The well-protected cockpit offers seating for up to 4 people and can be converted into a dining area. The optional bimini awning tops the comfort list, providing welcome shade and protection.

VERSATILITY

Highly versatile, the Activ 455 Cabin is perfect as a quick runabout, a fun day boat for family and friends or as an overnighter that sleeps two. The cockpit, with its banquette triple-seating plan, combines practicality and comfort as well as a table that makes just the spot for a picnic, while an optional second pilot bucket seat extends the full cockpit seating capacity up to five. Inside the cabin, optional central filler create an extra-wide berth, while the stow-away toilet storage and various other storage features throughout provide a maximum of free space.



ACTIV 455 CABIN

4



Bench seat for 3 people

2 & 3



Bench seating flips up to allow boat access via the stern.
Integrated step for boarding access

1



Swim ladder

5



Cockpit table for dining

6



Storage under cockpit seating

Pilot bucket seat.
Co-pilot bucket seat.



8 & 9



12

Cabin with double berth



11

Lockable bi-fold cabin entry door



13

Safe access to the bow

Ergonomic helm with mounting area for 7" GPS/Chart plotter



10

MODEL FEATURES

- 1. Swim ladder
- 2. Bench seating flips up to allow boat access via the stern
- 3. Integrated step for boarding access
- 4. Bench seat for 3 people
- 5. Cockpit table for dining
- 6. Storage under cockpit seating
- 7. High freeboard for children's safety
- 8. Pilot bucket seat
- 9. Co-pilot bucket seat
- 10. Ergonomic helm with mounting area for 7" GPS/Chart plotter
- 11. Lockable bi-fold cabin entry door
- 12. Cabin with double berth
- 13. Safe access to the bow
- 14. Anchor locker

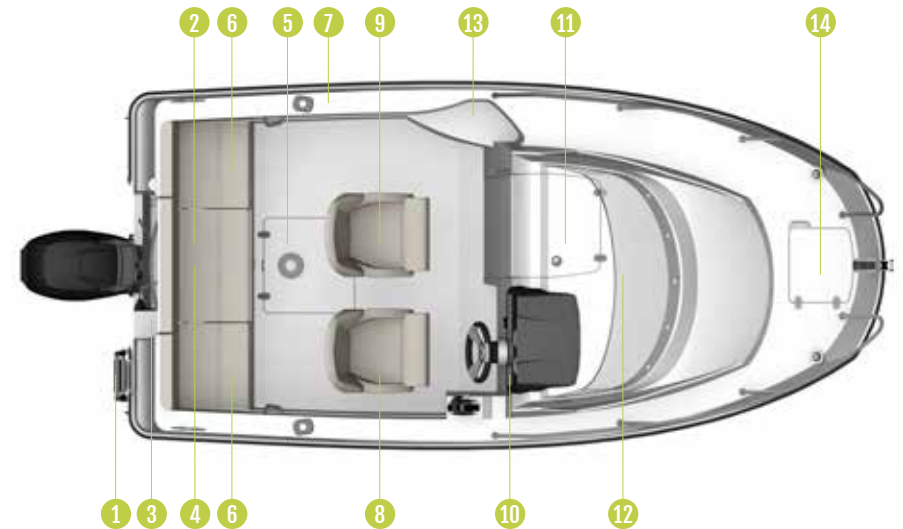

SPECIFICATIONS

ENGINE SPECIFICATIONS



Choose among our vast range of robust and powerful Mercury outboard engines, the most appreciated of all time. You'll have the very best and most up-to-the-minute engine power to take your boat out to enjoy the delights of the water.

Moreover, you will benefit from a national and international network of dealers for service. Additionally, a five-year warranty programme is applicable for all eligible Mercury outboard engines*. The programme will be offered to owners of new Mercury outboard engines**. The warranty applies to Mercury Verado® and FourStroke engines purchased in Europe, the Middle East, Africa and the CIS region.

The five years of comprehensive factory-backed coverage includes labour for failures caused by defects in material or workmanship. What's more, the new warranty is transferable if the engine is sold within the five-year period. The warranty applies to recreational use only.

- * Conditions and exclusions apply.
- ** Provided that all extended warranty conditions are met.

MERCURY ENGINE OPTION	ACTIV SUNDECK					ACTIV CRUISER				ACTIV CABIN		
	875	805	755	675	605	805	755	675	605	555	505	455
Mercury F40												x
Mercury F50												x
Mercury F60 / F60 CT											x	x
Mercury F80										x	x	
Mercury F100 / F100 CT										x	x	
Mercury F115 / F115 CT					x				x	x		
Mercury F150				x	x			x	x			
Mercury 200 V6		x	x	x		x	x	x				
Mercury 225 V6		x	x	x		x	x	x				
Mercury 250 V8 Verado	x	x	x			x	x					
Mercury 300 V8 Verado	x	x	x			x	x					
Mercury 350 L6 Verado	x	x				x						
Mercury 400 Verado	x	x				x						
2x Mercury 200 V6	x	x				x						
2x Mercury 225 V6	x											
2x Mercury 250 V8 Verado	x											
2x Mercury 250 V8 Verado with JPO	x											

MODEL SPECIFICATIONS

MODEL SPECIFICATIONS	ACTIV SUNDECK					ACTIV CRUISER				ACTIV CABIN		
	875	805	755	675	605	805	755	675	605	555	505	455
Length Overall (m)	8,06	7,88	7,23	6,66	5,94	7,88	6,99	6,48	6,02	5,50	5,41	4,44
Length of Hull (m)	7,99	7,63	6,95	6,45	5,75	7,63	6,91	6,20	5,76	5,29	4,81	4,30
Beam Maximum (m)	3,00	2,55	2,55	2,55	2,40	2,55	2,56	2,46	2,34	2,29	2,12	2,12
Height - Without Canvas (m)	2,71	2,71	2,21	2,10	2,02	2,26	2,03	1,83	1,75	1,71	1,64	1,63
Dry Weight (Kg)	2462	1820	1468	1123	970	1813	1440	1234	1074	865	613	538
Draft Hull (m)	0,60	0,56	0,55	0,44	0,44	0,60	0,55	0,49	0,48	0,42	0,36	0,35
Fuel Capacity (L)	450	280	280	200	160	280	280	230	160	110	50	25
CE Design Category	B/C	C	C	C	C	C	C	C	C	C	C	C
Maximum Number of People	10/12	9	8	8	7	9	8	7	6	6	5	4
Maximum Power (HP)	500	400	300	225	150	400	300	225	150	115	100	60
Maximum Power (kW)	368	294	221	165	110	294	221	165	110	84,6	73,6	44,1
Water Capacity (L)	100	80	80	45	45	80	80	45	21	NA	NA	NA
OB Shaft Length	1-XXL/2-XL	XL	XL	XL	XL	XL	XL	XL	XL	L	L	L



PACKS AND EDITIONS

PACKS AND EDITIONS	ACTIV SUNDECK					ACTIV CRUISER				ACTIV CABIN	
	875	805	755	675	605	805	755	675	605	555	505
SMART EDITION	X	X	X	X	X	X	X	X	X	X	
Cockpit Comfort Pack	x	x				x	x				
Cabin Comfort Pack	x		x			x	x				
Galley Pack	x										
Electronic Pack		x				x	x	x			
Bimini			x	x	x						
Bimini with Enclosed Canvas											x
Co-pilot Seat											x
Back bench filler with cushion											x
Cabin table & Berth Cushion/Filler											x
Upgraded Cockpit Table				x							
Mooring Kit	x	x	x	x	x	x	x	x	x		
Cockpit sun lounge								x	x		
Port Flip Seat			x								
Real teak cockpit table			x					x	x		
Refrigerator	x							x	x		
Cockpit Shower				x	x			x	x		
Ski Pole				x	x			x			
Bow Electrical Windlass			x	x							
Motorwell Bridge			x								
LED Courtesy lights								x			
Stereo Fusion with 4 speakers and USB port			x								
Stereo Fusion with 2 speakers and USB port				x	x						

PACKS AND EDITIONS	ACTIV SUNDECK					ACTIV CRUISER				ACTIV CABIN	
	875	805	755	675	605	805	755	675	605	555	505
COCKPIT COMFORT PACK	X	X				X	X				
Starboard Flip Seat	x	x									
Helm Flip Seat	x										
Cockpit sun lounge	x	x				x	x				
Refrigerator		x				x	x				
Stove LPG		x				x	x				
Shower								x			
Ski Pole								x			
Galley (sink w/press. water & stove)								x			
Port windscreen wiper								x			
Real teak cockpit table								x			
LED Courtesy Lights								x			

PACKS AND EDITIONS	ACTIV SUNDECK					ACTIV CRUISER				ACTIV CABIN	
	875	805	755	675	605	805	755	675	605	555	505
CABIN COMFORT PACK	X		X			X	X				
Enclosed Sea Toilet						x	x				
Curtains	x		x			x	x				
Cabin Table			x								
Berth Cushions/Filler			x								
Refrigerator	x										
Microwave	x										

PACKS AND EDITIONS	ACTIV SUNDECK					ACTIV CRUISER				ACTIV CABIN	
	875	805	755	675	605	805	755	675	605	555	505
ELECTRONIC PACK		X				X	X	X	X		
Simrad GPS/Chart Plotter 9" NSS evo 3 with HDI Transducer		x				x	x				
Simrad GPS/Chart Plotter Cruise 7 with HDI Transducer									x		
Simrad GPS/Chart Plotter Cruise 9 with HDI Transducer								x			
Stereo Fusion with 2 speakers and USB port								x	x		
Stereo Fusion with 4 speakers and USB port							x				
Stereo Fusion with 6 speakers and USB port		x				x					
VesselView Link digital interface		x				x	x				

PACKS AND EDITIONS	ACTIV SUNDECK					ACTIV CRUISER				ACTIV CABIN	
	875	805	755	675	605	805	755	675	605	555	505
PRIVILEGE PACK	X										
Flexiteek Flooring	x										
Upgraded foredeck sun lounge backrest	x										
Upgraded Upholstery (cockpit + helm seat + foredeck)	x										
Upgraded steering wheel	x										
Upholstered storage pads	x										
Headliner LED lighting	x										
Hatch Screen Cover (hatch cover and mosquito net)	x										

PACKS AND EDITIONS	ACTIV SUNDECK					ACTIV CRUISER				ACTIV CABIN	
	875	805	755	675	605	805	755	675	605	555	505
GALLEY PACK	X										
Refrigerator	x										
Stove LPG	x										

EQUIPMENT & OPTIONS

HULL & DECK	ACTIV SUNDECK					ACTIV CRUISER				ACTIV CABIN		
	875	805	755	675	605	805	755	675	605	555	505	455
Bow Roller		v	v	v	v	v	v	v	v	v	v	v
Swim Ladder	v	v	v	v	v	v	v	v	v	v	v	v
Navigation Lights	v	v	v	v	v	v	v	v	v	v	v	v
Forward line/anchor Locker	v	v	v	v	v	v	v	v	v	v	v	v
Self Bailing Cockpit	v	v	v	v	v	v	v	v	v	v	v	v
Rod holders		v								v	v	v
Hull side windows	v	v				v	v ¹					
Ski Pole	o	o	o	o/ED	o/ED	o	o/Cockpit/ED	o/ED				
Ski Tow Bar									o			
Swim Platforms	v	v	v	v	v	v	v	v	v	v		
Swim Platform Extensions	o	o	o	o	o	o	o			o	o	
Flexiteek Flooring	o/Prvlg	o	o	o	o	o	o	o	o	o		
Hull Color (dark grey)	o	o	o	o	o	o	o	o	o	o	o	o
LED Courtesy lights	v	v	v			v	Cockpit/ED	ED				
Under Water Lighting	o											
Motorwell Bridge	v	v	ED			v		v				

BOW	ACTIV SUNDECK					ACTIV CRUISER				ACTIV CABIN		
	875	805	755	675	605	805	755	675	605	555	505	455
Forward sun lounge			v	v	v	o	o	o	o	o		
Forward sun lounge with adjustable backrest	v	v										
Forward Sun Lounge with Automatically Adjustable Backrests	Prvlg											

CABIN	ACTIV SUNDECK					ACTIV CRUISER				ACTIV CABIN		
	875	805	755	675	605	805	755	675	605	555	505	455
Berths	4	4	2	2	2	4	2	2	2	2	2	2
Storage below Berth	v	v	v	v	v	v	v	v	v			
Dinette Seat Configuration	v	v	v									
Berth Cushions/Filler	v	v	Cabin/ED	v	v	v	v	v	v	o/ED	o	o
Sea Toilet			o					o				
Cabin Lights	v	v	v	v	v	v	v	v	v			
Ceiling Hedaline with integrated LED lightning	Prvlg											
Padded storage compartments	Prvlg											
Opening Portlights	v	v	v	v	v	v	v	v				
Cabin Table	v	v	Cabin/ED							o/ED		
Curtains	o/Cabin/ED	v	Cabin/ED			Cabin/ED	Cabin/ED					
Deck Hatch	v		v			v		v	v	v		
Hatch Screen Cover (hatch cover and mosquito net)	o/Prvlg											
Refrigerator	Cabin/ED								o/ED	o		
Microwave	Cabin/ED											

HELM	ACTIV SUNDECK					ACTIV CRUISER				ACTIV CABIN		
	875	805	755	675	605	805	755	675	605	555	505	455
Analog Speedometer/Tachometer										v	v	v
SmartCraft Speedometer/Tachometer	v ¹³	v	v	v	v	v	v	v	v	o	o	
Fuel Gauge										v ⁵		
Trim Gauge										v ⁵	v	v
Adjustable Steering Position	v	v	v				v					
Upgraded Steering Wheel	Prvlg											
12v electrical socket	v	v	v	v	v	v	v			v	v	v

COCKPIT	ACTIV SUNDECK					ACTIV CRUISER				ACTIV CABIN		
	875	805	755	675	605	805	755	675	605	555	505	455
Pilot Seat with Flip Bolster and Swivel		v	v	v	v	v	v	v	v	v	v	v
Dual Helm Seat with Bolster	v											
Co-pilot Seat		v	v	v	v	v	v	v	v	o/ED	o	o
Leaning post		o	o	o ⁴	o ⁴							
Cockpit sun lounge	o/Cockpit/ED	Cockpit/ED				Cockpit/ED	o/Cockpit/ED	o/ED	o/ED	o	o	
Aft Bench Seat	v	v	v	v	v	v	v	v	v	v	v	v
Storage below Aft Seat	v	v	v	v	v	v	v	v	v	v	v	v
Back bench filler with cushion										o/ED	o	o
Aft Seat Folding Backrest	v	v				v	v	v				
Aft Seat Extension L-Lounge	v	v	v			v	v					
Cockpit Cushions	v	v	v	v	v	v	v	v	v	v	v	v
Upgraded Upholstery (cockpit+helm seat)	Prvlg											
Cockpit table				v ⁶	v			v		v	v	v
Upgraded Cockpit Table		v	v	o/ED		v	v					
Cockpit Table with Laminated Top									v			
Real teak cockpit table	v		o/ED				o/Cockpit/ED	o/ED	o/ED			
12v Cool Box		v ⁷				v ⁷	v ⁷					
Cockpit Shower	v	v	o	o/ED	o/ED	v	Cockpit/ED	o/ED	o/ED			
Helm Seat Flip Seat	o/Cockpit/ED											
Starboard Flip Seat	o/Cockpit/ED	Cockpit/ED						o				
Port Flip Seat			o/ED									
Transom Door	v	v										

GALLEY	ACTIV SUNDECK					ACTIV CRUISER				ACTIV CABIN		
	875	805	755	675	605	805	755	675	605	555	505	455
Sink with Tap	v	v	o			v	Cockpit/ED	o				
Stove LPG	Gal/ED ¹²	Cockpit/ED	o			Cockpit/ED	Cockpit/ED					
Stove Butane								o				
Electric Grill	o											
Refrigerator	o/Gal/ED	Cockpit/ED	o			Cockpit/ED	Cockpit/ED	o/ED				

EQUIPMENT & OPTIONS

EQUIPMENT	ACTIV SUNDECK					ACTIV CRUISER				ACTIV CABIN		
	875	805	755	675	605	805	755	675	605	555	505	455
Shore Power	o	o				o						
Screen Inovtech 21'5" LED HD 1080 with DVD, USB, HDMI	o											
Stereo Fusion with 2 speakers and USB port				o/ED	o/ED			Elec/ED	o/ED			
Stereo Fusion with 4 speakers and USB port	o		o/ED				Elec/ED			o		
Stereo Fusion with 6 speakers and USB port		Elec/ED				Elec/ED						
Stereo Fusion with 6 speakers, USB port and subwoofer	o											
DAB Stereo kit with Antenna	o	o	o	o	o	o	o	o	o	o		
Simrad GPS/Chart Plotter Cruise 7 with HDI Transducer				o	o				Elec	o	o	o
Simrad GPS/Chart Plotter Cruise 9 with HDI Transducer								Elec/ED				
Simrad GPS/Chart Plotter 7" NSS evo 3 with HDI Transducer			o									
Simrad GPS/Chart Plotter 9" NSS evo 3 with HDI Transducer	o ²	Elec/ED				Elec/ED	Elec/ED					
Simrad GPS/Chart Plotter 12" NSS evo 3 with HDI Transducer	o											
Simrad VHF RS20	o											
VesselView link digital interface	o ⁸	Elec/ED	o			Elec/ED	Elec/ED					
Active Trim	o	o	o	o	o	o	o	o	o	o	o	
City water inlet	v											
Grey Water System with Dock Discharge	o ⁹	o	o			o	o					
Grey Water System with Manual Discharge	o											
Mooring kit*	o/ED	o/ED	o/ED	o/ED	o/ED	o/ED	o/ED	o/ED	o/ED	o	o	o
Single Battery System			v	v	v			v	v	v	v	v
Dual Battery System	v	v				v	v					
CO Monitor	v	v	v	v	v	v	v	v		v	v	v
Smoke Detector	v											
Water Heating	o											
Bow Thruster	o	o				o	o					
Diesel Heating	o						o					
Air Conditioner	o ¹⁰											
Bow Electrical Windlass	o	o	o/ED	o/ED	o	o	o	o				
Fire extinguisher, portable	v	v	v	v	v	v	v	v	v	v	v	v
Mechanical Steering											v	v
Hydraulic Steering	v	v	v	v	v	v	v	v	v	v		
Motor Bracket			o	o	o							
Electric Trim Tabs	o	v	o			v	o					
Zipwake Dynamic Trim-Control								o				
Joystick Piloting for Outboards	o ¹¹											
Electric & Manual Bilge Pump	v	v	v	v	v	v	v	v	v	v	v	v
Starboard Windscreen Wiper						v	v	v				
Port Windscreen Wiper	o					v	Cockpit/ED					
Windscreen Wash	o						Cockpit/ED					
OB Pre-Rigging	v	v	v	v	v	v	v	v	v	v	v	v

* Models < 7 meter : 4 fenders (53x13 cm), 4 fender covers with Quicksilver logo, 4 fender ropes (1,5 m) and 4 ropes (7 m)

Models > 7 meter : 6 fenders (61x16 cm), 6 fender covers with Quicksilver logo, 6 fender ropes (2 m) and 4 ropes (9 m)

HEAD	ACTIV SUNDECK					ACTIV CRUISER				ACTIV CABIN		
	875	805	755	675	605	805	755	675	605	555	505	455
Sink with Tap	v	v				v						
Shower	v											
Enclosed Sea toilet	v ³	o				Cabin/ED	Cabin/ED					
Opening Portlight	v	v				v	v					

COVER & CANVAS	ACTIV SUNDECK					ACTIV CRUISER				ACTIV CABIN		
	875	805	755	675	605	805	755	675	605	555	505	455
Mooring Cover	o					o	o	o	o	o	o	o
Transport Cover			o	o	o							
Console & bolster seats cover		o	o	o	o							
Console & leaning post cover		o	o	o	o							
Forward Sun Awning	o		o									
Bimini	o	o	o/ED	o/ED	o/ED	o	o	o	o			
Bimini with Enclosed Canvas	o	o	o			o	o	o	o	o/ED	o	o
Seat & Dash cover	o											
Seat Cover		A	A	A	A	A	A	A	A			
Console Cover			A	A	A							
Leaning Post Cover		A	A	A	A							

PACKS	ACTIV SUNDECK					ACTIV CRUISER				ACTIV CABIN		
	875	805	755	675	605	805	755	675	605	555	505	455
SMART Edition	o	o	o	o	o	o	o	o	o	o		
Cabin Comfort Pack	o/ED		o/ED			o/ED	o/ED					
Galley Pack	o/ED											
Cockpit Comfort Pack	o/ED	o/ED				o/ED	o/ED					
Electronic Pack		o/ED				o/ED	o/ED	o/ED	o			
Privilege Pack	o											

- 1 And integrated skylights on deck
- 2 Dual 9" monitor
- 3 With electric flushing system
- 4 With integrated 12v cool box
- 5 Only with analog instrumentation
- 6 Plastic table standard, upgraded fiberglass table part of Smart Edition or stand alone option
- 7 Upgraded to refrigerator in Cockpit Comfort Pack
- 8 Part of the GPS option
- 9 Choice between the system with dock discharge only or with manual outboard discharge
- 10 On shore power
- 11 Available on Twin Verado 250
- 12 Dual burner
- 13 Except with dual 9" GPS monitor
- 14 Automatic lifting system with gas springs part of the Privilege Pack

v=Standard o=Optional A=Accessory ED=Part of Smart Edition Elec=Part of Electronic Pack
 Cockpit=Part of Cockpit Pack Cabin=Part of Cabin Pack
 Gal=Part of Galley Pack Prvlg=Part of Privilege Pack GPS=included in the GPS option

As a company committed to continuous product improvement specifications are subject to change.



QUICKSILVER®

Explore our dealer network at
www.quicksilver-boats.com



© 2020 Brunswick Marine in EMEA. All Rights Reserved.

Brunswick Marine in EMEA continuously explores means to improve the products it designs, manufactures and distributes. Every effort is made to produce sales and service literature which is current. Changes to specifications of engines, boats and accessories are ongoing. This brochure should not be regarded as a precise guide to the latest specifications. This brochure is also not an offer for sales of any particular engine, boat or accessory. Distributors and dealers are not agents of Brunswick Marine in EMEA or one of its affiliates and they have no authority to bind Brunswick Marine in EMEA by any express undertaking or representation, including but not limited to representations of product, sales, applications or service nature. Not all products are available in all countries and some are available only in limited quantities. Some products shown in this catalogue are equipped with optional accessories. Please see your local dealer.

www.quicksilver-boats.com